STENTER CHAINS/CADENA PARA RAMAS/ACCESORIOS

CADENAS PARA TODAS LAS MARCAS Y REFERENCIAS DE RAMAS,
ACOPLES, GUIAS, PARTES Y ACCESORIOS



STENTER CHAIN ARTOS SYSTEM
CADENA ARTOS BABCOK

CADENA SISTEMA ARTOS No. 4010100-26-A



CADENA SISTEMA ARTOS No. 4010100-26-B



CADENA SISTEMA ARTOS No. 4010100-26-AP



CADENA SISTEMA ARTOS No. 4010100-26-P



CADENA SISTEMA ARTOS No. 4010100-26-L



CADENA SISTEMA ARTOS No. 3015150



ESLABONES CADENA SISTEMA ARTOS



4010100-25

4010100-25-I

4010100-30

DESLIZADORES SISTEMA ARTOS - BRONCE



4010100-A-2021

DESILIZADORES SISTEMA ARTOS - GRAFITADOS

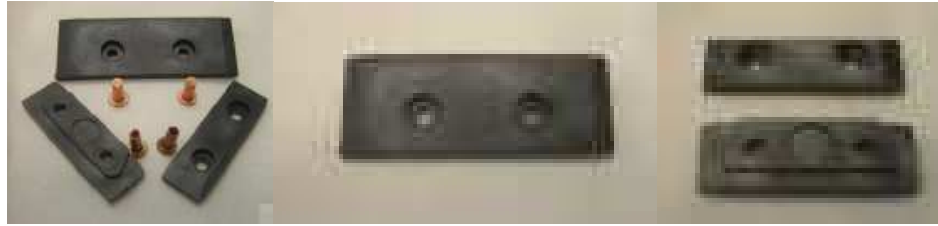

4010100-B-2021

BUJES ESLABONES CADENA ARTOS - GRAFITADOS



3015150-0106-SET



4010100-30-Z

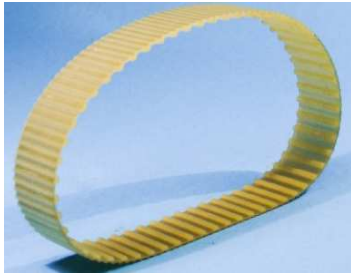

BANDA PLANA TIPO 1
728 x 32 mm

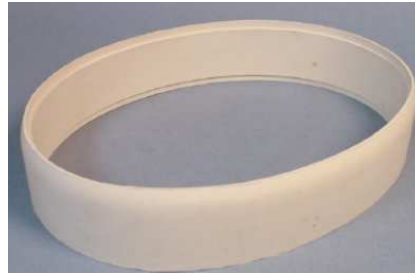

BANDA PLANA TIPO 2
190 x 42 mm



ANILLO DE GOMA
86X 58 mm

STENTER PIN / CLIPS ARTOS SYSTEM
PINZAS Y CLIPS ARTOS BABCOK



PINZA COMBINADA ARTOS BABCOK - PIN / CLIP
4010100-CR1



PINZA COMBINADA ARTOS BABCOK - PIN / CLIP
4010100-SV1



PINZA COMBINADA ARTOS BABCOK - PIN / CLIP
4010100-CRZ1



PINZA COMBINADA ARTOS BABCOK - PIN / CLIP
4010100-SVZ1

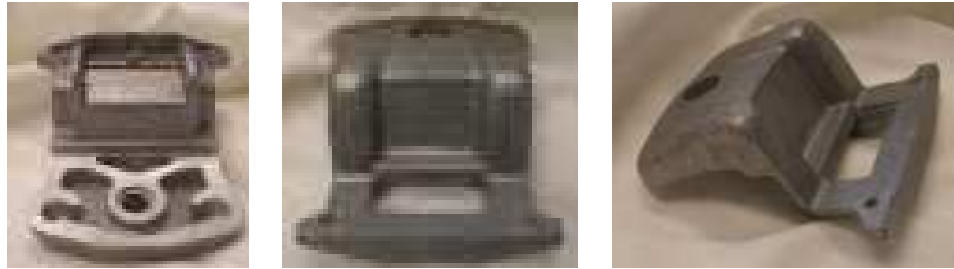

PINZA CORTA ARTOS BABCOK - PIN / CLIP 4010104-CR

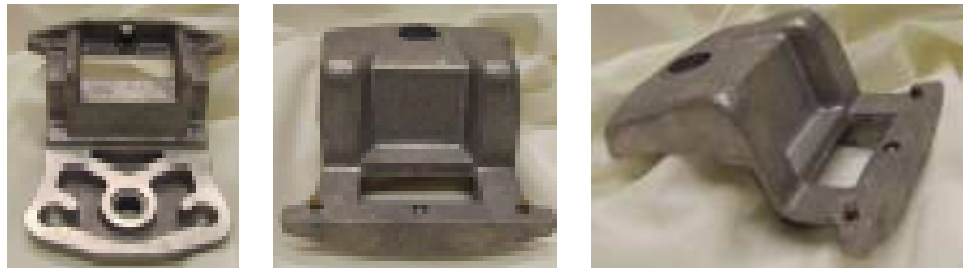

PINZA CORTA ARTOS BABCOK - PIN / CLIP 4010104-SV



PINZA CORTA ARTOS BABCOK - PIN / CLIP 4010105-SV

ACCESORIES CLIPS ARTOS SYSTEM
ACCESORIOS CLIPS ARTOS BABCOK

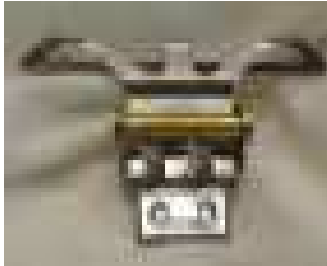

PINZA PROTECTORA DESAPINADO ARTOS BABCOK – PIN
PROTECTOR 4010105-01



PINZA PROTECTORA DESAPINADO ARTOS BABCOK – PIN
PROTECTOR 4010105-02-S



PINZA PROTECTORA DESAPINADO ARTOS BABCOK – PIN
PROTECTOR 4010106-01

STENTER CHAIN KRANTZ SYSTEM CADENA KRANTZ

CADENA SISTEMA KRANTZ No. 4010500-100



CADENA SISTEMA KRANTZ No. SK 303.0146



CADENA SISTEMA KRANTZ No. SK 301.0015



CADENA SISTEMA KRANTZ No. SK 40105330-K30



CADENA SISTEMA KRANTZ No. SK 40105331-K30

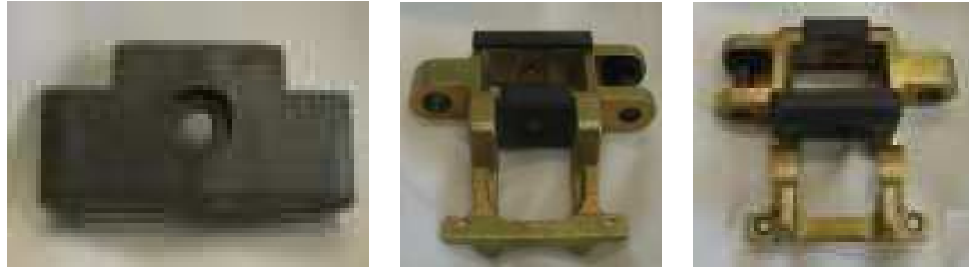

DESLIZADORES CADENA SISTEMA KRANTZ 40 x 5 x 996 mm -
5 Perforaciones Avellanadas - Hasta 230°



DESLIZADORES CADENA SISTEMA KRANTZ 20 x 5 x 996 mm -
5 Perforaciones Avellanadas - Hasta 230°



DESLIZADORES CADENA SISTEMA KRANTZ 50 x 5 x 996 mm -
con 5 Perforaciones Avellanadas- Hasta 230°



DESLIZADORES CADENA SISTEMA KRANTZ
18 (12) x 3.5 x 996 mm -
Sin Perforaciones - Hasta 230°



CLIPS PARTS KRANTZ - PARTES CLIPS KRANTZ

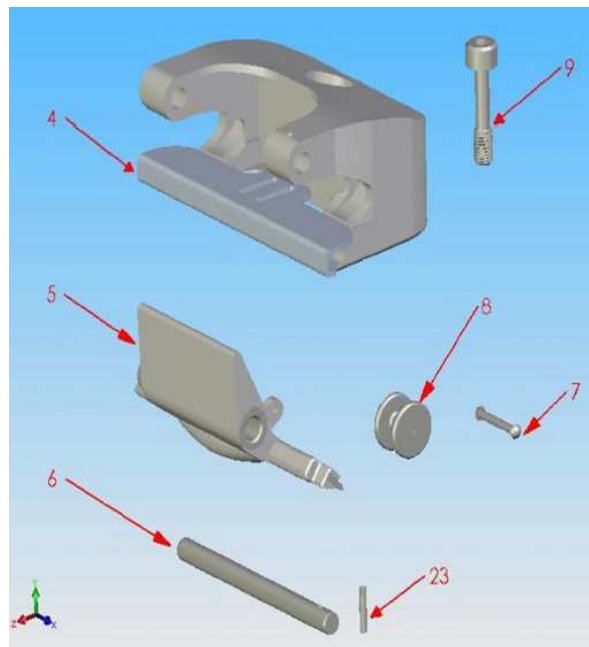

CHAIN PARTS KRANTZ - PARTES CADENA KRANTZ

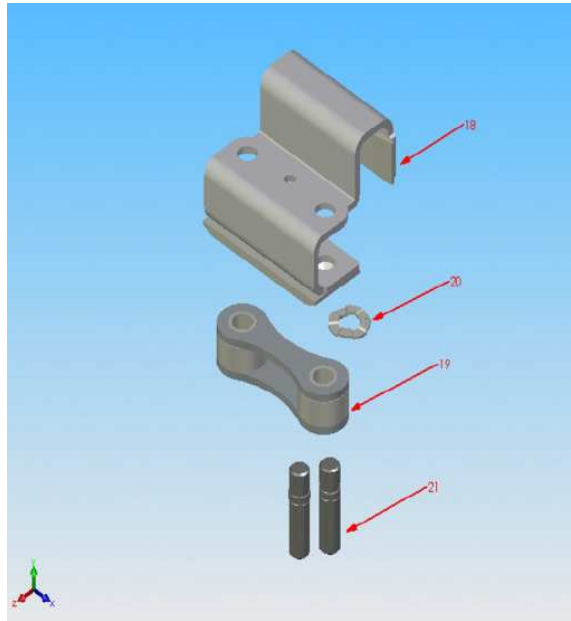

CLIPS KRANTZ SYSTEM ACCESORIOS CLIPS KRANTZ



PINZA PROTECTORA DESAPINADO KRANTZ 6 DEDOS
PIN PROTECTOR 4010503

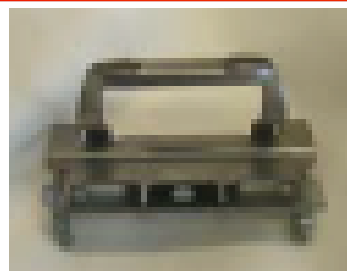
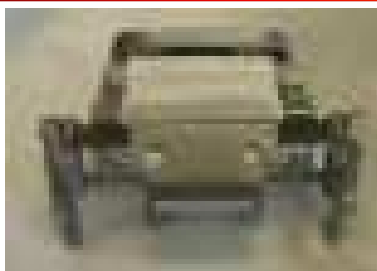

PINZA PROTECTORA DESAPINADO KRANTZ 4 DEDOS
PIN PROTECTOR 4010504

BANDAS DE ALIMENTACION KRANTZ



BANDA NEOPRENO
164,5 x 210 x 38,5 mm



BANDA PLANA TIPO 1
575 x 38 x 4.5 mm



BANDA PLANA TIPO 2
575 x 38 mm



BANDA PLANA TIPO 3
575 x 38 x 4.5 mm



REMACHADORA DESLIZADORES KRANTZ - HS 500



REMACHES KRANTZ - 5 X 8 mm 5 x 10

Cra.49 B no.171 A - 92 - Teléfonos: + 57 1 5275448 - Fax: (571) 6728993 / (571) 5275448 www.jmltda.com - Email:
jmairgunther@yahoo.com - jordanmairguntherltda@yahoo.com - Móviles: 315- 8005453 - A.A.50713
Bogotá DC - Colombia - Sudamérica

STENTER CHAIN MONFORTS SYSTEM
CADENA MONFORTS

CADENA COMPLETA MONFORTS No.4010600-22-TO-N



BUJES LUBRICADORES DESLIZANTES
CADENA MONFORTS



BUJES TEFLON
CILINDRICOS



BUJES TEFLON
CON SOPORTE



BUJES TORLON
CILINDRICOS



ESLABON SOP. CADENA MONFORTS No. 4010607-CR

BUJES CADENA MONFORTS SENCILLOS Y CON GRASERA



DESLIZADORES CADENA SISTEMA MONFORTS
12,8 x 9 x 200 mm



DESLIZADORES CADENA SISTEMA MONFORTS
170 mm



STENTER PIN / CLIPS MONFORTS SYSTEM
PINZAS Y CLIPS MONFORTS

PINZA COMBINADA MONFORTS - PIN / CLIP 4010601-SV2



PINZA COMBINADA MONFORTS - PIN / CLIP 4010601-2



STENTER CHAIN BRUCKNER SYSTEM
CADENA BRUCKNER

CADENA SISTEMA BRUCKNER No. 3015202-A - SK917



CADENA SISTEMA BRUCKNER No. 3013200-A - SK952



CADENA SISTEMA BRUCKNER No. 3015200 - SK935



CADENA SISTEMA BRUCKNER No. 3015200 - SK935



CADENA SISTEMA BRUCKNER No. 4010207 - SK962 / SK 690



CADENA BRUCKNER VERTICAL STANDARD

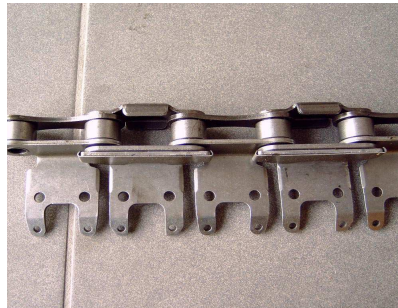

CADENA BRUCKNER VERTICAL SK 999

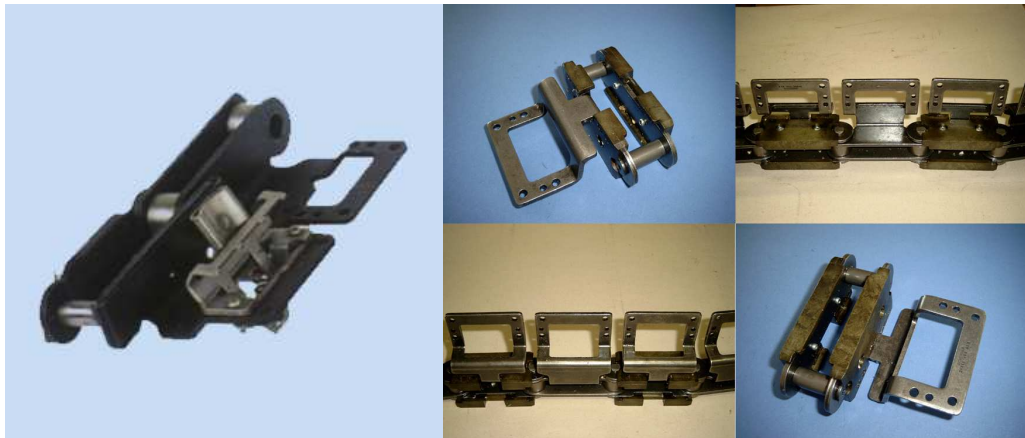

DESLIZADORES SISTEMA BRUCKNER 25 x 5 x 597 mm
con 4 Perforaciones M5- Hasta 230°



DESLIZADORES SISTEMA BRUCKNER 55 x 5 x 597 mm
con 4 Perforaciones M5- Hasta 230°



DESLIZADORES SISTEMA BRUCKNER 25 x 4,9/4.1 x 203 mm
Sin Perforaciones - Hasta 230°



DESLIZADORES CADENA BRUCKNER 1039700-G / K



STENTER PIN / CLIPS BRUCKNER SYSTEM
PINZAS Y CLIPS BRUCKNER

PINZA COMBINADA BRUCKNER - PIN / CLIP 4010202F-A



PINZA COMBINADA BRUCKNER - PIN / CLIP 4010202A



PINZA COMBINADA BRUCKNER-PIN/CLIP 4010202F-B



PINZA COMBINADA BRUCKNER-PIN/CLIP 4010202-B



PINZA COMBINADA BRUCKNER - PIN / CLIP 4010203



PINZA COMBINADA BRUCKNER - PIN / CLIP 4010204



STENTER CHAIN FAMATEX SYSTEM
CADENA FAMATEX

CADENA VERTICAL FAMATEX No.4017156

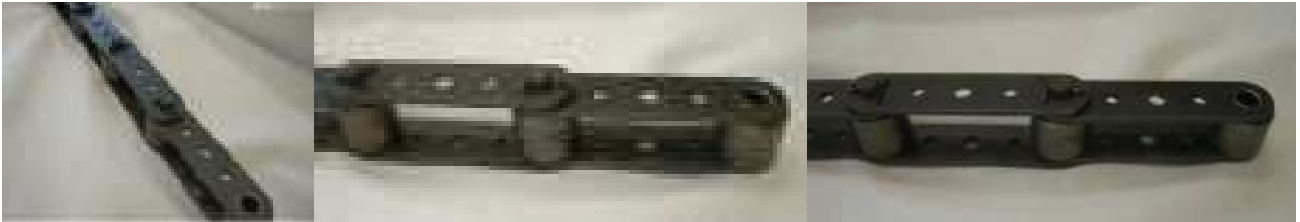

STENTER CHAIN PARTS, PIN LINK FAMATEX SYSTEM
PARTES DE CADENA FAMATEX

PIN CLIP FAMATEX No. 4017157-SV



PIN CLIP FAMATEX No. 4017157-SV

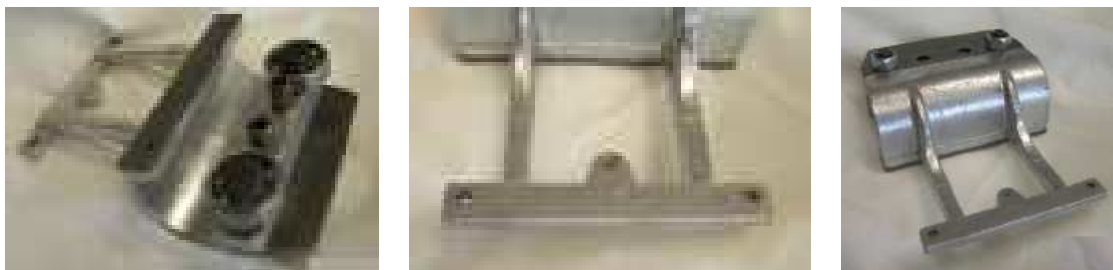

DESLIZADORES SISTEMA FAMATEX 495 mm



PINZA PROTECTORA DESAPINADO FAMATEX 6 DEDOS



DIFFERENT STENTER CHAINS
OTRAS CADENAS PARA RAMA



CADENA VERTICAL RAMA
No. 3001



CADENA VERTICAL RAMA
No. 20415

SISTEMAS DE ALIMENTACION RAMAS

ACCESORIOS PARA STENTER (1)

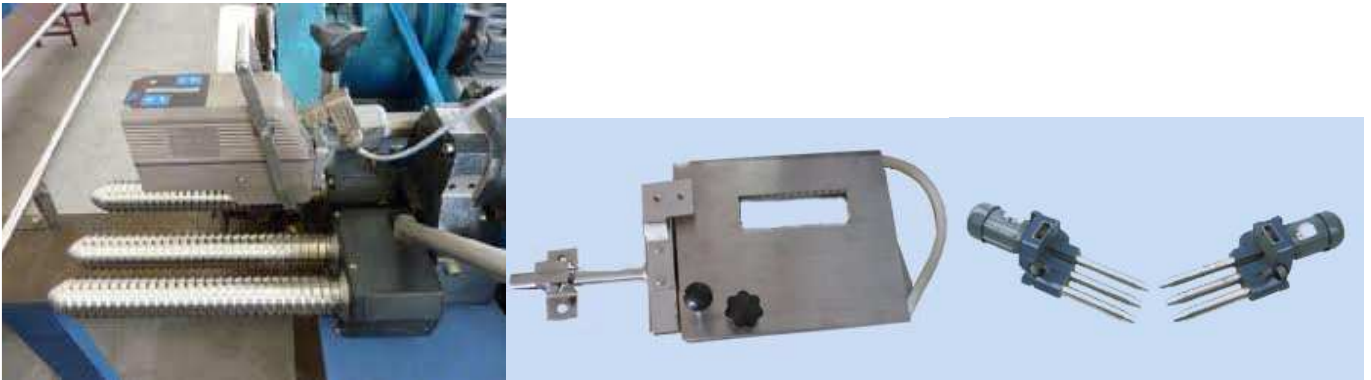

Nuestra gama de productos es muy grande. Nos permite ofrecer muchas soluciones. Nuestro KnowHow es bastante extenso lo que nos permite proveer piezas que son de difícil consecución para todas las marcas y todos los modelos de ramas.

